

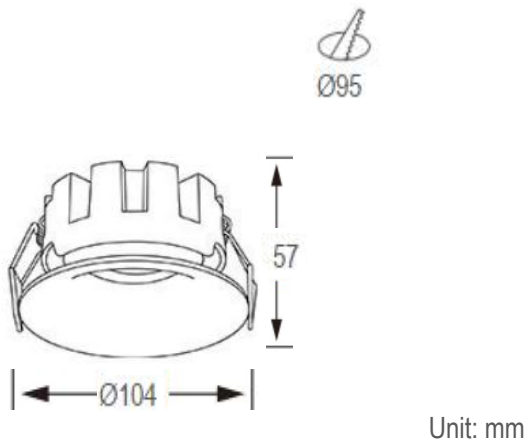

•Dimension drawing

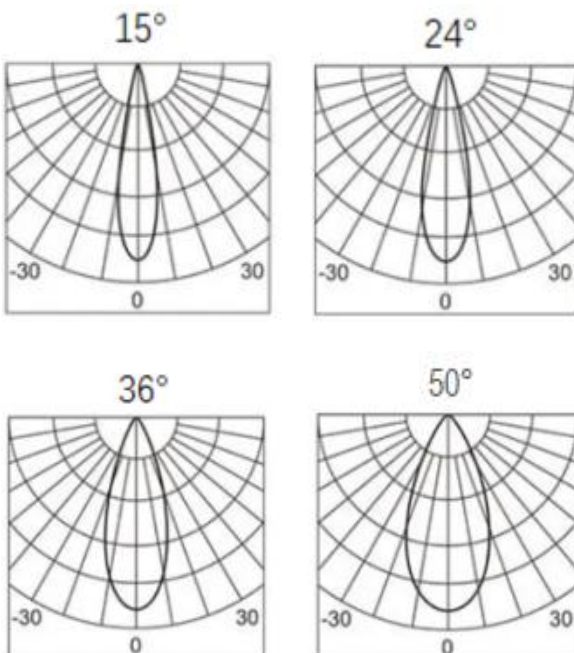

•Lighting Distribution



•Description

LED Downlighter is made of aluminum body, with curved aluminum outer trim design, the trim colors includes shining silver/Gold/White/Black options. It is also ideal for all commercial lighting application.

•Specification

Ref Number	GR-DL-95B(18W)
Power	18Watt ±5%
Lumens	1500-1800lm
LED Type	COB
CCT	2700k-3000K/4000K/5700-6000K
CRI	>92
SDCM	< 3
LED driver	External driver included
Control Way	ON/OFF
Input voltage	110/ 220-240VAC 50/60Hz
Efficiency	>80%
Power factor	>0.5
THD	<15%
Free flicker	Yes
Beam angle	15/24/36/50° options
Materials	Die-cast aluminum
Finished	White / Black/Gold/Shining silver option
UGR	<19 anti glare
Surge protection	1KV
Mounting	Recessed
IP Rating	IP20 (IP44 for front)
Dimension	Ø104*H57mm
Cutout	Ø95mm
Working temp	-25°C ~ +50°C
Storage temp	-30°C ~ +55°C
Standard	CE LVD EMC RoHS
Working life	>50000Hrs
Warranty	3Years/5Years
Insulation class	Class II

•Options(Addtional Cost)

- DC12V/24V/36V/48V/60V input
- Triac/0-10V/DALI dimmable
- SDCM:2
- Emergency backup (1-3hours with 3-5W)
- Power factor: >0.9

•Package

QTY:50PCS/CTNS CTN Size: 63*26*68CM
Gross Weight(KG): 21.5KG/CTNS