



## Description

This is a recessed commercial spotlight with a tilt-shape design; the trim is tilted, the complete lights include two parts, one is a tilt frame, the second is an LED module with an LED driver or a GU10 LED bulb. Available in matt white and black in finished colors. Widely used wall washer lighting for commercial areas such as hotels, hospitals, and offices.

## Specification

Ref Number	GR-DL-7WGU
Power	7Watt ±5%
Lumens	630-700lm
LED Type	COB
CCT	2700k-3000K/4000K/5700-6000K
CRI	>90
SDCM	< 3
LED driver	External driver included
Control Way	ON/OFF
Input voltage	110/ 220-240VAC 50/60Hz
Efficiency	>86%
Power factor	>0.5 or 0.9
THD	<15%
Free flicker	Yes
Beam angle	15/24/36° options
Materials	Die-cast aluminum
Finished	White / Black options
UGR	<19 anti glare
Surge protection	1KV
Mounting	Recessed
IP Rating	IP20
Dimension	Ø86*H100mm
Cutout	Ø75mm
Working temp	-25°C ~ +50°C
Storage temp	-30°C ~ +55°C
Standard	CE LVD EMC RoHS
Working life	>50000Hrs
Warranty	3Years/5Years
Insulation class	Class II

## Dimension drawing

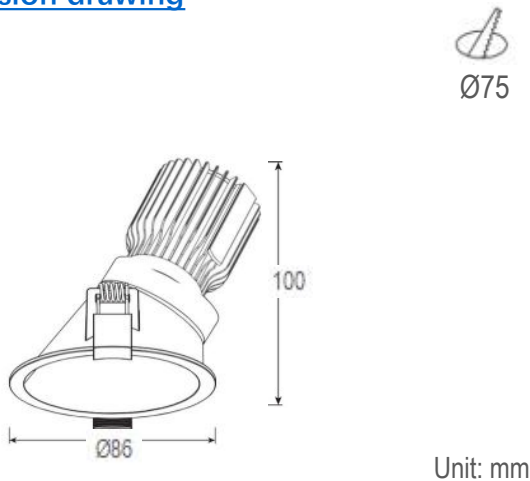

Unit: mm

## Lighting Distribution

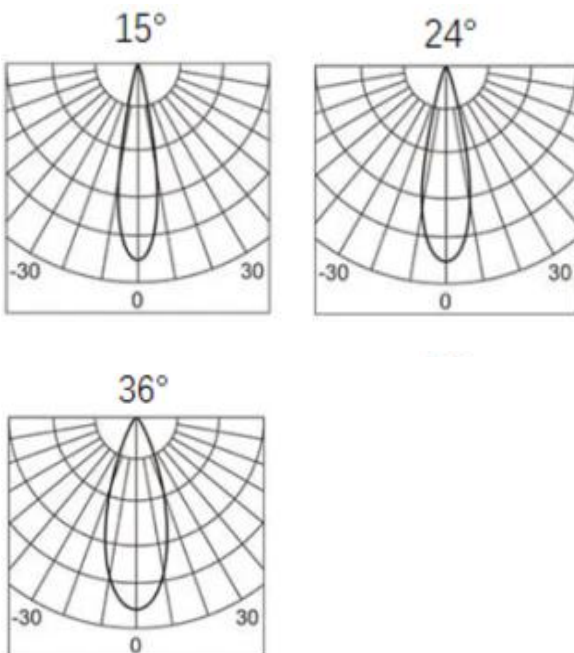

## Options

- DC12V/24V/36V/48V/60V input
- Triac/0-10V/DALI dimmable
- SDCM:2
- Emergency backup (1-3hours with 3-5W )
- Plug

## Package

QTY: CTN Size:  
Gross Weight(KG):