

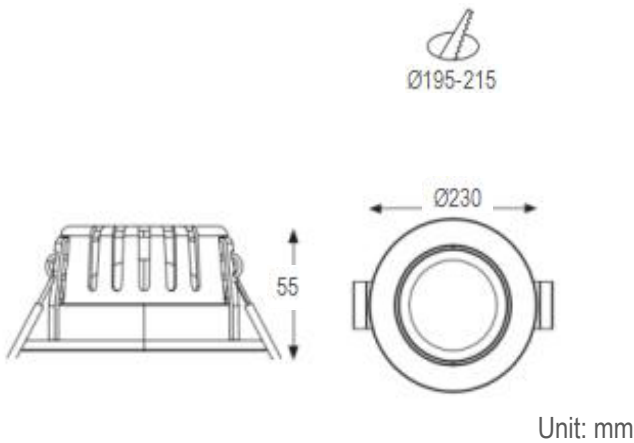

## •Dimension drawing

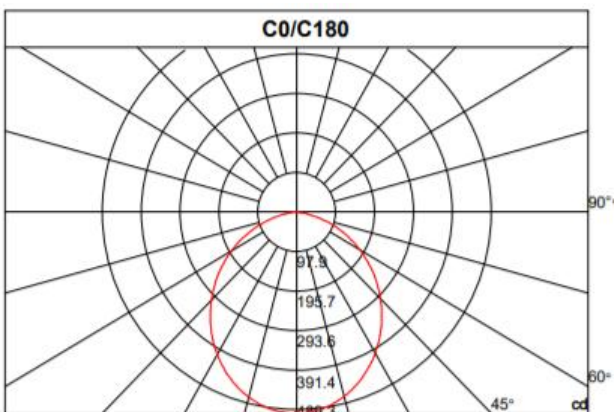

## •Lighting Distribution



## •Description

LED Downlighter is made of aluminum body and plastic reflector, the reflector colors includes shining silver/Gold/White/Black options. and the light body can be white or black finished. It is also ideal for all commercial lighting application.

## •Specification

Ref Number	GR-DL-35WB-11
Power	35Watt ±5%
Lumens	3000-3500lm
LED Type	SMD
CCT	2700k-3000K/4000K/5700-6000K
CRI	>80 or 90
SDCM	< 3
LED driver	External driver included
Control Way	ON/OFF
Input voltage	110/ 220-240VAC 50/60Hz
Efficiency	>86%
Power factor	>0.5 or 0.9
THD	<15%
Free flicker	Yes
Beam angle	120°
Materials	Die-cast aluminum+ plastic reflector
Finished	Matt White / Black options
Reflector colors	Shinning silver/Gold/White/Black options
Surge protection	1KV
Mounting	Recessed
IP Rating	IP20 (IP44 for front)
Dimension	Ø230*H55mm
Cutout	Ø195-215mm
Working temp	-25°C ~ +50°C
Storage temp	-30°C ~ +55°C
Standard	CE LVD EMC RoHS
Working life	>50000Hrs
Warranty	3Years/5Years
Insulation class	Class II

## •Options

- DC12V/24V/36V/48V/60V input
- Triac/0-10V/DALI dimmable
- SDCM:2
- Emergency backup (1-3hours with 3-5W )
- Plug

## •Package

QTY: CTN Size:  
Gross Weight(KG):