

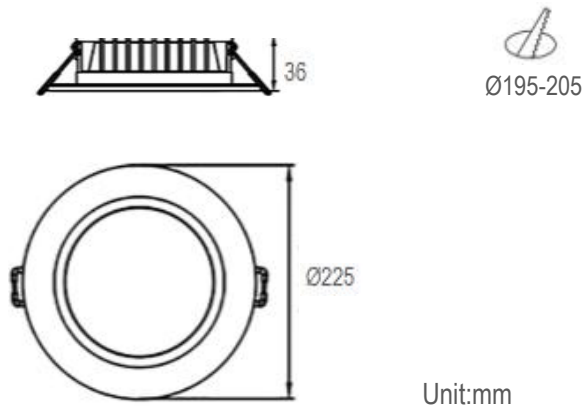

•Dimension drawing

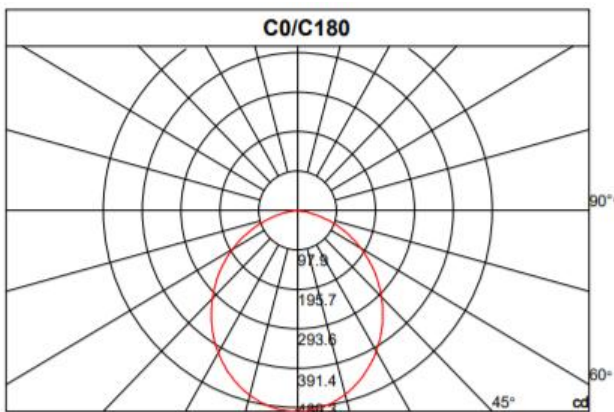

•Lighting Distribution



•Description

This slim recessed downlight features an ultra-thin body design, only 35mm height, perfectly fitting shallow ceiling cavities without compromising lighting performance. The backlit emission will ensure better heat performance and higher lumen output. Widely used for various interior projects.

•Specification

Ref Number	GR-DL-30WY
Power	30Watt ±5%
Lumens	2700-3000lm
LED Type	SMD
CCT	2700k-3000K/4000K/5700-6000K
CRI	>80
SDCM	< 3
LED driver	External driver included
Control Way	ON/OFF
Input voltage	110/ 220-240VAC 50/60Hz
Efficiency	>86%
Power factor	>0.5
THD	<15%
Free flicker	Yes
Beam angle	120°
Materials	Die-cast aluminum+PC cover
Finished	White / Black options
Insulation class	Class II
Surge protection	1KV
Mounting	Recessed
IP Rating	IP20
Dimension	Ø225*H36mm
Cutout	Ø195-205mm
Working temp	-25°C ~ +50°C
Storage temp	-30°C ~ +55°C
Standard	CE LVD EMC RoHS
Working life	>50000Hrs
Warranty	2/3Years

•Options(Additional Cost)

- DC12V/24V/36V/48V/60V input
- Triac/0-10V/DALI dimmable
- SDCM:2
- PF>0.9
- Emergency backup

•Package

QTY: CTN Size:
Gross Weight(KG):