

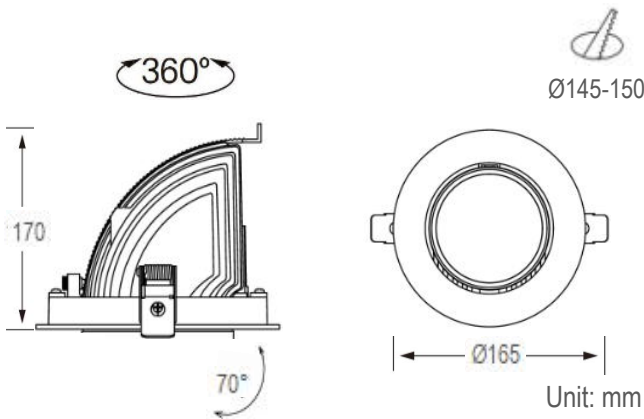

•Dimension drawing

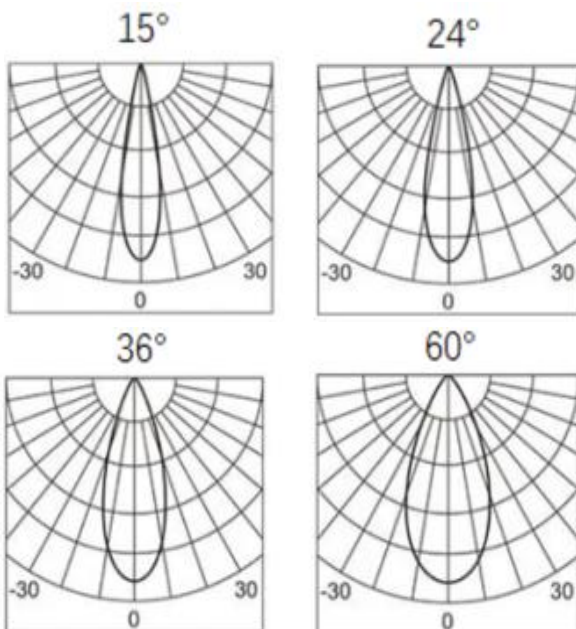

•Lighting Distribution



•Description

The standout feature of the gimbal LED downlight is its adjustable head for directional lighting. This flexibility offers 360° horizontal rotation and can be adjusted up to 70° vertically. You can hide the lights within the outer ring for vertical directional lighting or extend them for wall-washing spotlights. The ability to direct light precisely makes it a popular choice for a wide range of commercial lighting applications.

•Specification

Ref Number	GR-DL-30WG-17
Power	30Watt ±5%
Lumens	2700-3000lm
LED Type	COB
CCT	2700k-3000K/4000K/5700-6000K
CRI	>92
SDCM	< 3
LED driver	External driver included
Control Way	ON/OFF
Input voltage	110/ 220-240VAC 50/60Hz
Efficiency	>87%
Power factor	>0.9
THD	<15%
Free flicker	Yes
Beam angle	15/24/36°/60° options
Materials	Die-cast aluminum.
Finished	Matt White / Black options
UGR	<19 anti-glare
Surge protection	1KV
Mounting	recessed
IP Rating	IP20 (IP44 for front)
Dimension	Ø165*H170mm
Cutout	Ø145-150mm
Working temp	-25°C ~ +50°C
Storage temp	-30°C ~ +55°C
Standard	CE LVD EMC RoHS
Working life	>50000Hrs
Warranty	3Years/5Years
Insulation class	Class II

•Options

- DC12V/24V input
- Triac/0-10V/DALI dimmable
- SDCM<2
- Emergency backup

•Package

QTY: CTN Size:
Gross Weight(KG):