



Description

LED Downlight adopt eyeball design with low glare value, the eyeball colors and trim can be White/Black options. It is 360° rotation +30° adjustable direction for lighting. Widely used for commercial areas. . The lamp body and reflector are available in black and white to meet the diverse lighting needs of residential and commercial applications

Specification

Ref Number	GR-DL-24WG-9
Power	24Watt ±5%
Lumens	2200-2400lm
LED Type	COB
CCT	2700k-3000K/4000K/5700-6000K
CRI	>92
SDCM	< 3
LED driver	External driver included
Control Way	ON/OFF
Input voltage	110/ 220-240VAC 50/60Hz
Efficiency	>87%
Power factor	>0.9
THD	<15%
Free flicker	Yes
Beam angle	15/24/36/55° options
Materials	Die-cast aluminum
Finished	White / Black options
UGR	<19 anti glare
Surge protection	1KV
Mounting	Recessed
IP Rating	IP20 (IP44 for front)
Dimension	Φ108*75mm
Cutout	Ø95mm
Working temp	-25°C ~ +50°C
Storage temp	-30°C ~ +55°C
Standard	CE LVD EMC RoHS
Working life	>50000Hrs
Warranty	3Years/5Years
Insulation class	Class II

Dimension drawing

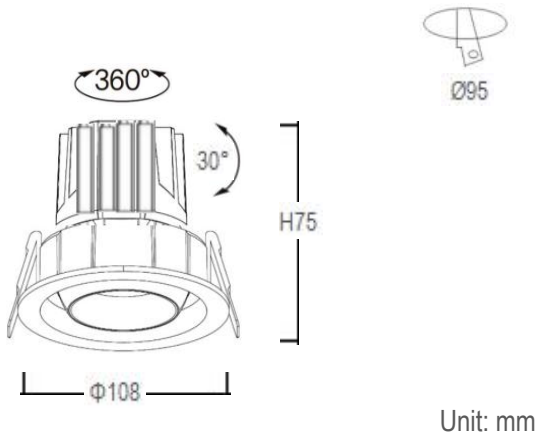

Lighting Distribution

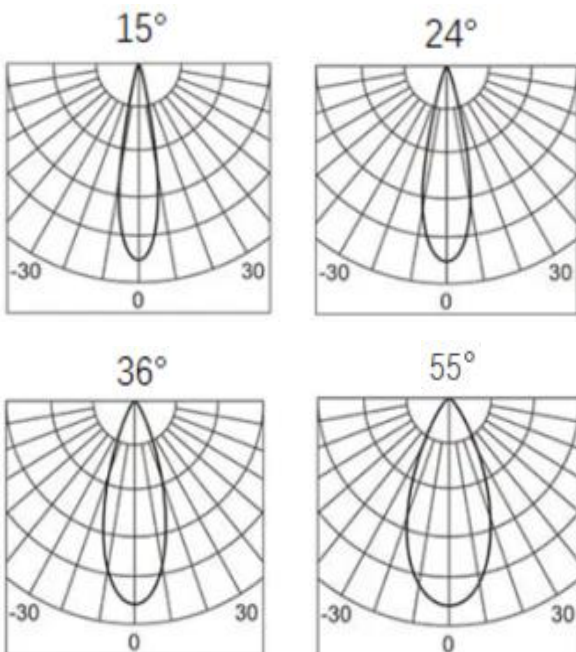

Options(Additional Cost)

- Emergency backup
- Triac/0-10V/DALI dimmable
- SDCM:2

Package

QTY: CTN Size:
Gross Weight(KG):