

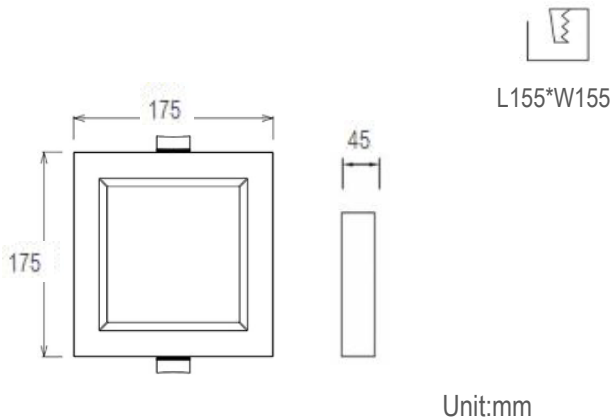

## •Dimension drawing

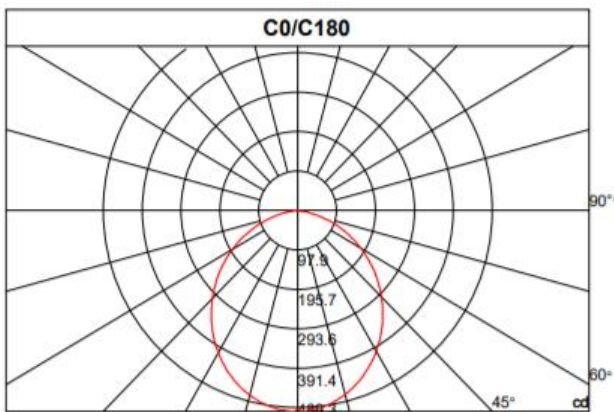

## •Lighting Distribution



## •Description

This recessed square LED downlight includes both a white frame and black housing, a deep design with different reflector color options like white/black/gun black/ Chrome(shining silver and gold). They are suitable for commercial spaces such as bars, cafes, exhibition halls, and high-end retail stores

## •Specification

Ref Number	GR-DL-20WE-8
Power	20Watt ±5%
Lumens	1800-2000lm
LED Type	SMD
CCT	2700k-3000K/4000K/5700-6000K
CRI	>80
SDCM	< 3
LED driver	External driver included
Control Way	ON/OFF
Input voltage	110/ 220-240VAC 50/60Hz
Efficiency	>86%
Power factor	>0.5
THD	<15%
Free flicker	Yes
Beam angle	120°
Materials	Die-cast aluminum+Plastic reflectors
Finished	White / Black options
Reflector	Black/white/shining silver/gold/gun black.
Surge protection	1KV
UGR	<19
IP Rating	IP20 (IP44 for front)
Dimension	L175*W175*H45mm
Cut out	L155*W155mm
Working temp	-25°C ~ +50°C
Storage temp	-30°C ~ +55°C
Standard	CE LVD EMC RoHS
Working life	>50000Hrs
Warranty	3Years/5Years
Insulation class	Class II

## •Options(Additional Cost)

- Emergency backup
- Triac/0-10V/DALI dimmable
- SDCM:2
- PF>0.9

## •Package

QTY: CTN Size:  
Gross Weight(KG):