



Description

The recessed LED downlights are commercial level with the perfect heat sink for heat performance, using a famous brand for LED chips and driver, and the light body is available in matt white and matt black. Widely used for commercial lighting for hotels, hospitals, shopping malls, offices, etc.

Specification

Ref Number	GR-DL-20WB-4
Power	20Watt ±5%
Lumens	1800-2000lm
LED Type	SMD
CCT	2700k-3000K/4000K/5700-6000K
CRI	>80
SDCM	< 3
LED driver	Built- driver included
Control Way	ON/OFF
Input voltage	110/ 220-240VAC 50/60Hz
Efficiency	>86%
Power factor	>0.5
THD	<15%
Free flicker	Yes
Beam angle	120°
Materials	Die-cast aluminum+Opal diffuser
Finished	White / Black options
Insulation class	Class II
Surge protection	1KV
Mounting	Recessed
IP Rating	IP20 (IP44 for front)
Dimension	Φ160*H60mm
Cutout	Ø145mm
Working temp	-25°C ~ +50°C
Storage temp	-30°C ~ +55°C
Standard	CE LVD EMC RoHS
Working life	>50000Hrs
Warranty	3Years/5Years

Dimension drawing

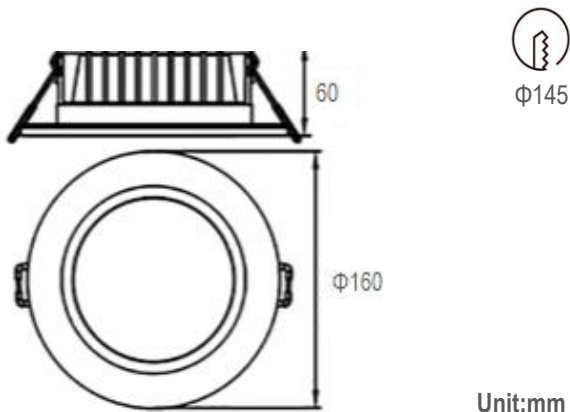

Unit:mm

Lighting Distribution

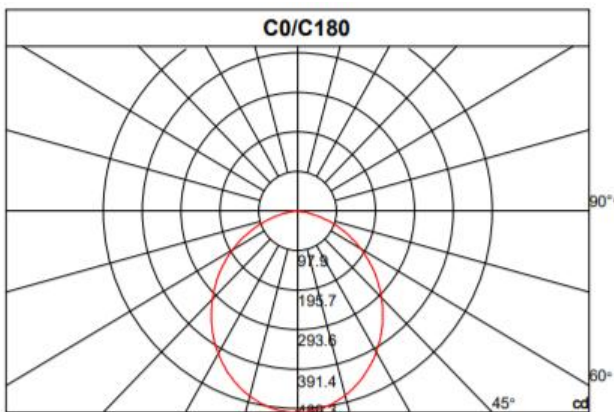

Options(Additional Cost)

- CIR90
- Triac/0-10V/DALI dimmable
- SDCM:2
- PF>0.9
- Emergency backup

Package

QTY: CTN Size:

Gross Weight(KG):