

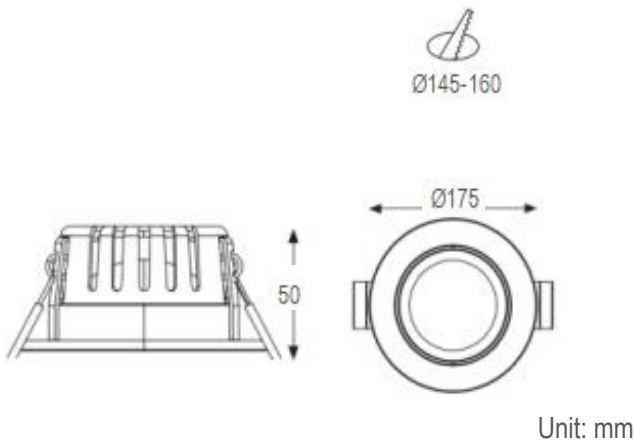

•Dimension drawing

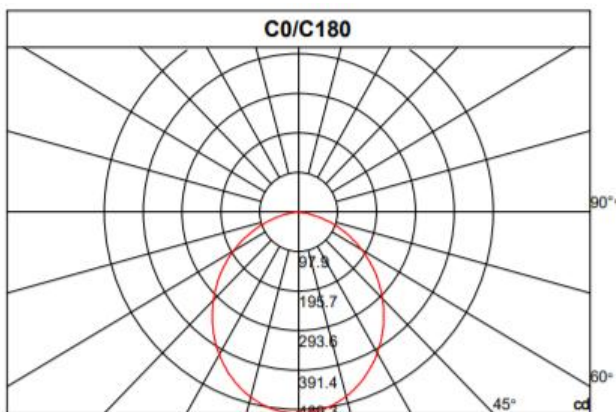

•Lighting Distribution



•Description

LED Downlighter is made of aluminum body and plastic reflector, the reflector colors includes shining silver/Gold/White/Black options. and the light body can be white or black finished. It is also ideal for all commercial lighting application.

•Specification

Ref Number	GR-DL-20WB-11
Power	20Watt ±5%
Lumens	1800-2100lm
LED Type	SMD
CCT	2700k-3000K/4000K/5700-6000K
CRI	>80 or 90
SDCM	< 3
LED driver	External driver included
Control Way	ON/OFF
Input voltage	110/ 220-240VAC 50/60Hz
Efficiency	>86%
Power factor	>0.5 or 0.9
THD	<15%
Free flicker	Yes
Beam angle	120°
Materials	Die-cast aluminum+ plastic reflector
Finished	Matt White / Black options
Reflector colors	Shinning silver/Gold/White/Black options
Surge protection	1KV
Mounting	Recessed
IP Rating	IP20 (IP44 for front)
Dimension	Ø175*H50mm
Cutout	Ø145-160mm
Working temp	-25°C ~ +50°C
Storage temp	-30°C ~ +55°C
Standard	CE LVD EMC RoHS
Working life	>50000Hrs
Warranty	3Years/5Years
Insulation class	Class II

•Options

- DC12V/24V/36V/48V/60V input
- Triac/0-10V/DALI dimmable
- SDCM:2
- Emergency backup (1-3hours with 3-5W)
- Plug

•Package

QTY: CTN Size:
Gross Weight(KG):