

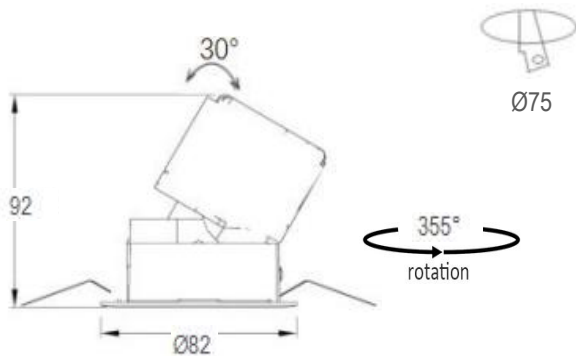

•Dimension drawing



Unit:mm

•Lighting Distribution

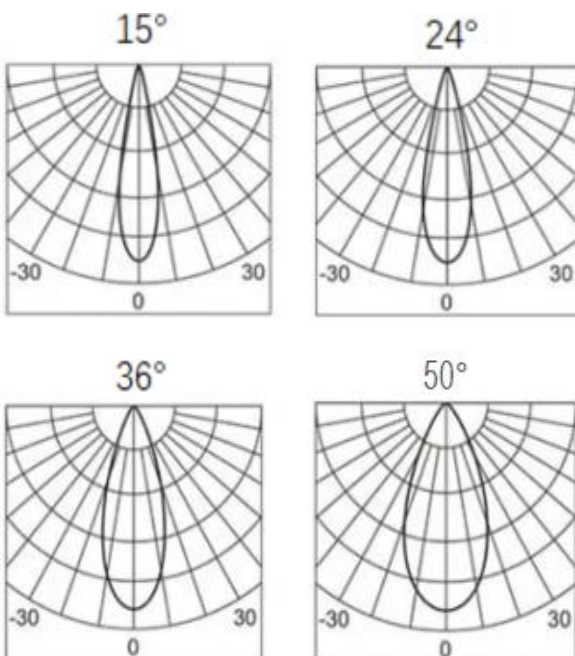

•Description

LED Downlight adopt deep anti-glare design and adjustable 30°, with top quality aluminum as housing and bridgelux chips, delivers a superior LED alternative that's up to 60% more energy efficient than the conventional downlight retrofits. It is also ideal for all commercial lighting applications. White/black/Silver/Gun black/gold reflectors optional.

•Specification

Ref Number	GR-DL-15WG-3
Power	15Watt ±5%
Lumens	1330-1500lm
LED Type	COB
CCT	2700k-3000K/4000K/5700-6000K
CRI	>92
SDCM	< 3
LED driver	External driver included
Control Way	ON/OFF
Input voltage	110/ 220-240VAC 50/60Hz
Efficiency	>86%
Power factor	>0.5
THD	<15%
Free flicker	Yes
Beam angle	15/24/36/50° options
Materials	Die-cast aluminum+Plastic reflectors
Finished	White / Black options
Reflector color	Black/white/gold/gun back/shining silver
UGR	<19 anti glare
Mounting	Surface mounted
IP Rating	IP20 (IP44 for front)
Dimension	Ø82*H92mm
Cutout	Ø75mm
Working temp	-25°C ~ +50°C
Storage temp	-30°C ~ +55°C
Standard	CE LVD EMC RoHS
Working life	>50000Hrs
Warranty	3Years/5Years
Insulation class	Class II

•Options(Additional Cost)

- Emergency backup
- Triac/0-10V/DALI dimmable
- SDCM:2
- PF>0.9
- Surge protection 2.5KV

•Package

QTY:50PCS/CTNS CTN Size: 58*22*58CM
Gross Weight(KG): 20KG/CTNS