

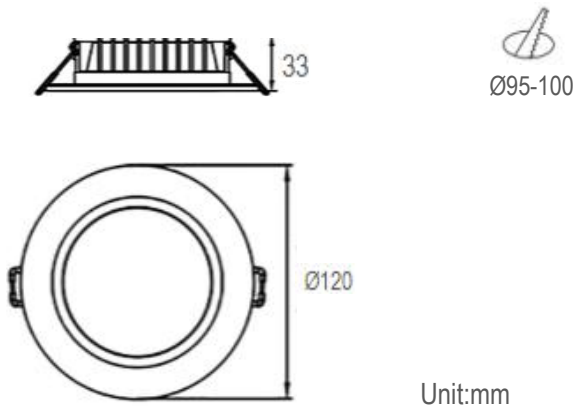

Description

This slim recessed downlight features an ultra-thin body design, only 35mm height, perfectly fitting shallow ceiling cavities without compromising lighting performance. The backlit emission will ensure better heat performance and higher lumen output. Widely used for various interior projects.

Dimension drawing



Lighting Distribution

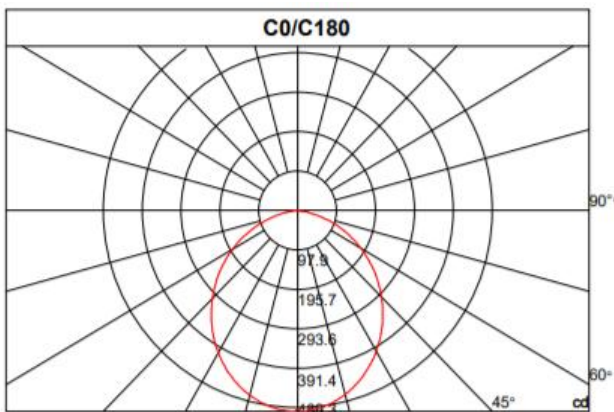

Specification

Ref Number	GR-DL-10WY
Power	10Watt ±5%
Lumens	900-1000lm
LED Type	SMD
CCT	2700k-3000K/4000K/5700-6000K
CRI	>80
SDCM	< 3
LED driver	External driver included
Control Way	ON/OFF
Input voltage	110/ 220-240VAC 50/60Hz
Efficiency	>80%
Power factor	>0.5
THD	<20%
Free flicker	Yes
Beam angle	120°
Materials	Die-cast aluminum+PC cover
Finished	White / Black options
Insulation class	Class II
Surge protection	1KV
Mounting	Recessed
IP Rating	IP20
Dimension	Ø120*H33mm
Cutout	Ø95-100mm
Working temp	-25°C ~ +50°C
Storage temp	-30°C ~ +55°C
Standard	CE LVD EMC RoHS
Working life	>50000Hrs
Warranty	2/3Years

Options(Additional Cost)

- DC12V/24V/36V/48V/60V input
- Triac/0-10V/DALI dimmable
- SDCM:2
- PF>0.9
- Emergency backup

Package

QTY: CTN Size:
Gross Weight(KG):