



Description

This gypsum downlight is a kind of trimless downlight. It features a plaster gypsum frame, a removable light source part, an aluminum heat sink, and a metal rimless recessed housing. The removable light source design offers flexibility for replacement. The deep reflector provides an anti-glare effect, making it a perfect choice for residential or commercial lighting.

Specification

Ref Number	GR-DL-10WF-R
Power	10Watt ±5%
Lumens	850-1000lm
LED Type	COB
CCT	2700k-3000K/4000K/5700-6000K
CRI	>90
SDCM	< 3
LED driver	External driver included
Control Way	ON/OFF
Input voltage	110/ 220-240VAC 50/60Hz
Efficiency	>84%
Power factor	>0.5
THD	<15%
Free flicker	Yes
Beam angle	15/24°/36° options
Heat Sink	Die-cast aluminum
Face ring	Gypsum
Insulation class	Class II
Surge protection	1KV
UGR	<19 anti glare
IP Rating	IP20 (IP44 for front)
Dimension	Ø102*H117mm
Cut out	Ø105mm
Working temp	-25°C ~ +55°C
Storage temp	-30°C ~ +60°C
Standard	CE LVD EMC RoHS
Working life	>50000Hrs
Warranty	3Years/5Years

Dimension drawing

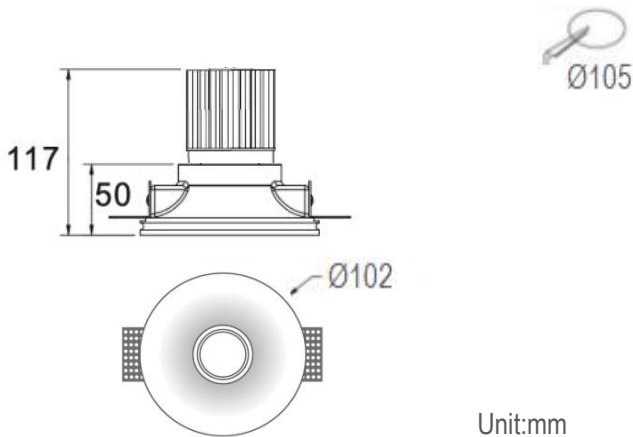

Unit:mm

Lighting Distribution

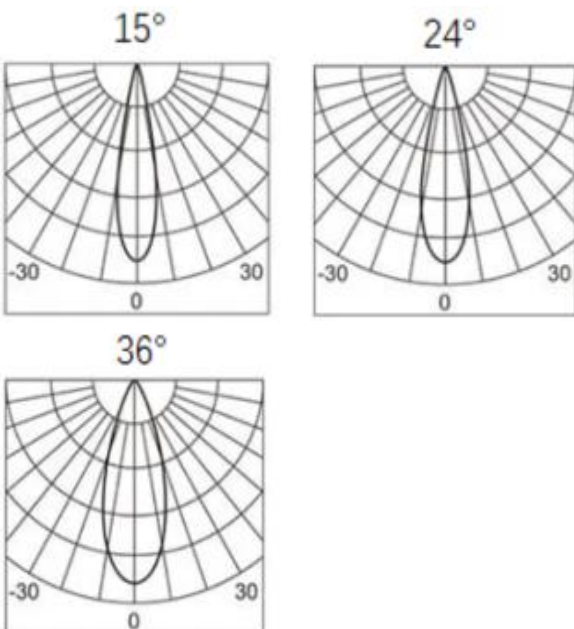

Options(Additional Cost)

- Emergency backup
- Triac/0-10V/DALI dimmable
- SDCM:2
- PF>0.9
- LED driver with Plug

Package

QTY: CTN Size:
Gross Weight(KG):