



OUTDOOR LED FLOODLIGHT

Ref No: GR-FL-300WA

CE RoHS IP66



LED Flood light is made of die-cast aluminum and Toughed glass cover+ lens cover,delivers a superior LED alternative that's up to 60% more energy efficient than the conventional HPS,Metal halide flood light retrofits.
Surge protection up to 6KV which will keep its stable quality.

Complete Product Data

Order Number	GR-FL-300WA
Total Wattage	300W±5%
Mounting Type	Wall mounted/Pole mounted/ground mounted
Dimension(mm)	430*400*58mm
IK Grade	IK08
IP Grade	IP66
Luminaries Lumens	45000-48000lm
Beam angle	30°/60°/90°/120°
Working temperature	-25°C ~ +55°C
Certificates standard	CE LVD EMC RoHS
Warranty	3/5Years
Package	43*34*46CM/5pcs/34KG

Electrical Data

LED driver Brand	MOSO /SUNCOM/Philips/Meanwell Brand
Input voltage	100/220-277VAC 50/60Hz
Output voltage	/
Output current	/
Power Factor	>0.95
Surge protection	6KV-10KV
Efficiency	>90% @230V
IP Grade	IP66
THD	<10% @230V
Control Way	ON/OFF
Life time	>50000Hrs
Protection	Short circuit, open circuit, overcurrent, overvoltage protection
Certificates	CE CB CCC ENEC ROHS
Warranty	3/5Years

Material&Housing Data

Housing Color	Black as standard
Housing Material	Die-cast aluminum
Cover material	Toughed glass + PMMA Lens cover
Reflector	High temperature resistant nano reflective cup
Bracket	Metal
Gland connector	Stainless steel

Photometric Data

LED chip brand	Philips/Bridgelux
Chip type	SMD
Color temperature	2700-2800K/3000-3200K/4000-4500K/ 5700-6000K/ 6000-6500K
CRI	>Ra70 or 80
Life time	>50000Hrs
Lumens	160-180lm/W
SDCM	<5
Lumens maintenance	99.9%@1000hrs/ 99%@3000hrs /98%@10000hrs. (LM80)

Optional

Dimming Type	0-10V / DALI DIMMABLE
Dimming driver brand	MOSO / MEANWELL
Emergency backup	/
Input voltage	AC/DC12V/24V/48V optional
Motion sensor	Yes, Radar sensor available optional

Dimension

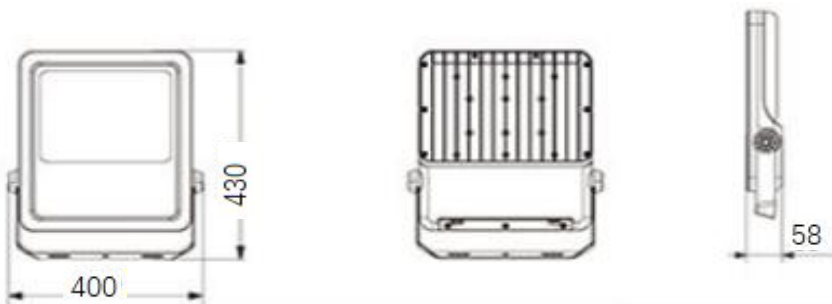

Unit:mm

Lighting Distribution

