



SQUARE RECESSED DOWNLIGHT

Ref No: GR-DL-20WV



LED Downlight adopt deep anti-glare design, it is ok to be rotation 30°, different reflector colors option (white/black/silver/gun black/gold) and consists of CREE/CITIZEN/Bridgelux chips, delivers a superior LED alternative that's up to 60% more energy efficient than the conventional downlight retrofits.

Complete Product Data

Order Number	GR-DL-20WV
Total Wattage	20W±5% (25W available if needed)
Mounting Type	Recessed
Dimension(mm)	L105*W105*H138mm
Outcut(mm)	L95*W95mm
IP Grade	IP44
Luminaries Lumens	1800-2100lm (2300-2550lm for 25W)
Beam angle	15/24/36°/55°
Working temperature	-30°C ~ +55°C
Certificates standard	CE LVD EMC RoHS
Warranty	3/5Years
Package	/

Control Gear Data

LED driver brand	LiFud/Eagleries/Philips/Osram
Input voltage	220-240VAC 50/60Hz
Output voltage	30-42Vdc
Output current	450-600mA
Power Factor	>0.5 as standard, >0.9 optional
Surge protection	1KV
Efficiency	>85% @230V
IP Grade	IP22
THD	<15% @230V
Dimmable	No, but available to select it as Triac/0-10V/DALI if needed
Free flicker	Yes
Protection	Short circuit, open circuit, overcurrent, overvoltage protection
Certificates	CCC、RCM、CE、CB
Warranty	3/5Years

Material&Housing Data

Housing Color	Matt white trim+ black heat sink
Housing Material	Aluminum
Cover material	/
Reflector	polycarbonate, White/black as standard, silver/rose gold optional
Lens	PMMA
Clips	Metal

Photometric Data

LED chip brand	Bridgelux as standard, Osram/CREE Optional
Chip type	COB
Color temperature	2700-2800K/3000-3200K/4000-4500K/ 5700-6000K/ 6000-6500K
CRI	>Ra90 (97 Max)
Life time	>50000Hrs
Lumens	120-140lm/W
SDCM	<5 or <3
Lumens maintenance	99.9%@1000hrs/ 99%@3000hrs /98%@10000hrs. (LM80)

Optional

Dimming Type	Triac dim/ 0-10V dimmable optional
Dimming driver brand	LiFud/Eagleries/Philips/Osram
Emergency backup	Battery backup for 1-3W with 1-3hrs duration

Dimension

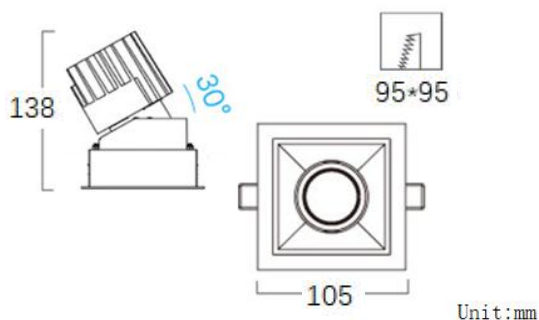

Lighting Distribution

