



DEEP IP65 DOWNLIGHT

Ref No: GR-DL-12WW-01



This downlight is improved from common downlight adding a waterproof rubber, to increase protection level can be IP65, so that it can be used for some moisture environments such as kitchen, balcony, or bathroom. And it is anti-glare design, different reflector colors - white, black, gun black options, very stylish and high level.



Complete Product Data

Order Number	GR-DL-12WW-01
Total Wattage	12W±5%
Mounting Type	Recessed mounted
Dimension(mm)	Φ87*72mm
Outcut(mm)	Φ75mm
IP Grade	IP65
Luminaries Lumens	1100-1300lm
Beam angle	60°
Working temperature	-30°C ~ +55°C
Certificates standard	CE LVD EMC RoHS
Warranty	3/5Years
Package	/

Electrical Data

LED driver Type	Eagleries/LiFud/Osram/Philips options
Input voltage	220-240VAC 50/60Hz
Output voltage	30-42Vdc
Output current	300-350mA
Power Factor	>0.5
Surge protection	1KV
Efficiency	>84% @230V
IP Grade	IP22
THD	<15% @230V
Dimmable	No, but available to select it as Triac/0-10V/DALI if needed
Free flicker	Yes
Protection	Short circuit, open circuit, overcurrent, overvoltage protection
Certificates	CE LVD EMC RoHS CB ENEC
Warranty	3/5Years

Material&Housing Data

Housing Color	Coffe for heat sinke, white trim
Housing Material	Aluminum
Cover material	PC Cover
Gland connector	Kirsite
Recessed clips	Metal
Reflector	Plastic, white/black/gun black optional

Photometric Data

LED chip brand	Bridgelux /Osram
Chip type	COB
Color temperature	2700-2800K/3000-3200K/4000-4500K/ 5700-6000K/ 6000-6500K
CRI	>Ra90 (Max 97)
Life time	>50000Hrs
Lumens	120-150lm/W
SDCM	<5 or <3
Lumens maintenance	99.9%@1000hrs/ 99%@3000hrs /98%@10000hrs. (LM80)

Optional

Dimming Type	Triac dim/ 0-10V dim/ DALI dimmable
Dimming driver brand	KOPU EAGLERISE
Emergency backup	Battery backup with 1-3Hours for 3-5Watt
Reflector colors	Black/White or Gun black options
Honeycomb	Options



Dimension

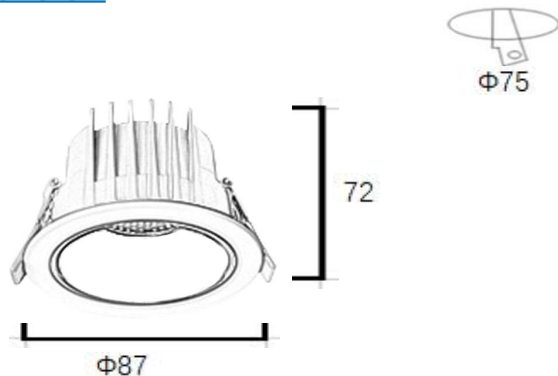

Unit:mm

Lighting Distribution

