



LED ADJUSTABLE STREETLIGHT

Ref No: GR-SL-300WH



This street lights adopts latest design--adjustable joint+ Tool free,and it is also available to added safe cut-off switch. It is consist of top quality aluminum housing and chips,led driver, it is the best solution to do high level projects and to win bids. Top materials such as aluminum housing,isolated driver with 6/10/20kv surge protection which will keep its stable quality.

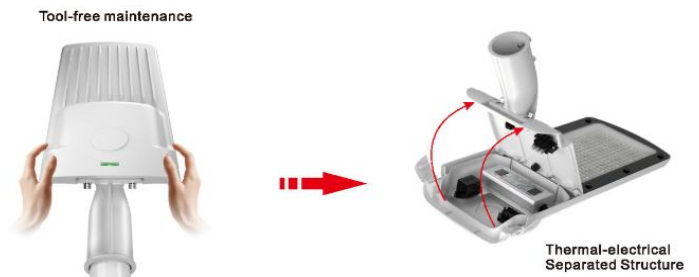

Complete Product Data

Order Number	GR-SL-300WH
Total Wattage	300W±5%
Install pole diameter	D60mm
Dimension(mm)	788x335x115mm
Outcut(mm)	/
IP Grade	IP66
Luminaries Lumens	36000-45000lm
Beam angle	60°/90°/120°/T2M/T3M/T4M(70°x140°)
Working temperature	-25°C ~ +60°C
Certificates standard	CE LVD EMC RoHS
Warranty	3/5Years
Package	/

Control Gear/Driver Data

LED driver Type	Philips/Moso/Meanwell/SUNCOM brand
Input voltage	220-240VAC 50/60Hz
Output voltage	36-48Vdc
Output current	5500-6000mA
Power Factor	>0.95
Surge protection	6-10KV
Efficiency	>91% @230V
IP Grade	IP66
THD	<10% @230V
Dimmable	No
Working temperature	-25°C ~ +55°C
Protection	Short circuit, open circuit, overcurrent, overvoltage protection
Certificates	TUV CE ROHS SAA ENEC
Warranty	3/5Years

Material&Housing Data

Housing Color	Grey
Housing Material	Die-cast aluminum
Cover material	Toughed glass
Reflector	Nano reflective material
Bracket	/
Cable	High temperature resistant, anti-aging, insulated rubber cable.

Photometric Data

LED chip brand	Philips
Chip type	SMD 3030
Color temperature	3000-3200K/4000-4500K/ 5700-6000K
CRI	>Ra70
Life time	>50000Hrs
Lumens	140-180lm/W
SDCM	<5
Lumens maintenance	99.9%@1000hrs/ 99%@3000hrs /98%@10000hrs. (LM80)

Optional

Dimming Type	PMW/0-10V/DALI dimmable optional
Dimming driver brand	MOSO MEAN WELL OSRAM
SPD	10KV/20KV SPD
Input voltage	AC/DC12V/24V/48V optional
Photocell	Yes, dusk to dawn device optional

Dimension

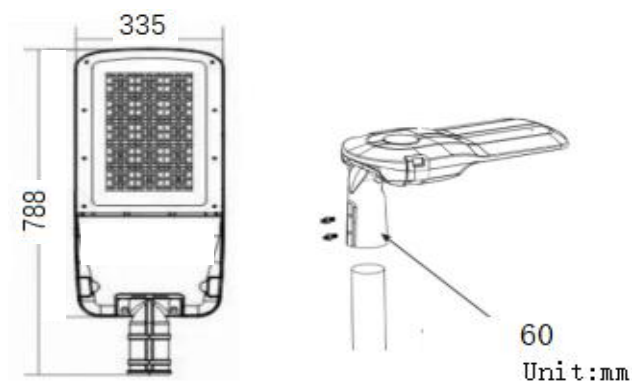

Lighting Distribution

