



LED TRACK LIGHT

Ref No: GR-TL-35WB



This track light is made of aluminum housing(black/white finished) and high CRI COB Chips,beam angle is 15/24/36° optional. It is a perfect choice to be for museum,clothing stores,supermarkets,kitchen etc.By the way, it is available to do 2lines,3lines,4lines(3Phases) types and to be 0-10V or DALI dimmable.

Complete Product Data

Order Number	GR-TL-35WB
Total Wattage	35W±5%
Mounting Type	Track mounted
Dimension(mm)	Φ100*150mm
Outcut(mm)	/
IP Grade	IP20
Luminaries Lumens	3300-3600lm
Beam angle	15/24°/36°
Working temperature	-25°C ~ +55°C
Certificates standard	CE LVD EMC RoHS
Warranty	3/5Years

Control Gear/Driver Data

LED driver brand	LiFud/Eagleries brand
Input voltage	220-240VAC 50/60Hz
Output voltage	30-42Vdc
Output current	900-950mA
Power Factor	>0.9
Surge protection	1KV
Efficiency	>87% @230V
IP Grade	IP20
THD	<10% @230V
Dimmable	No, but available to select it as Triac/0-10V/DALI if needed
Free flicker	Yes
Protection	Open Circuit Protection / short Circuit protection/
Certificates	CE CB TUV ENEC
Warranty	3/5Years

Material&Housing Data

Housing Color	White or black finished
Housing Material	Aluminum
Lens	/
Reflector material	PC reflector
Track heads	Plastic, black/white finished
Connector	/

Photometric Data

LED chip brand	Bridgelux
Chip type	COB
Color temperature	2700-3000K/3200-3500K/4000-4500K/ 5700-6000K/ 6000-6500K
CRI	>Ra92
Life time	>50000Hrs
Lumens	120-140lm/W
SDCM	<5
Lumens maintenance	99.9%@1000hrs/ 99%@3000hrs /98%@10000hrs. (LM80)

Optional

Dimming Type	Triac dim/ 0-10V dim/ DALI dimmable optional
Dimming driver brand	Eagleries
Emergency backup	/
Track Heads	3Wires / 4wires(3 phases) track heads

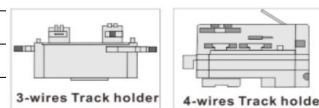

Dimension

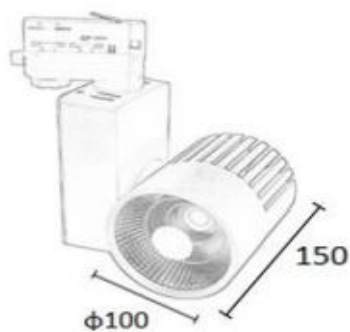

Unit:mm

Lighting Distribution

