



RECESSED DOUBLE DOWNLIGHT

Ref No: GR-DLG-2*20WE



This square Downlight adopt deep anti-glare design, it is ok to be rotation 25°, and consists of die-cast aluminum housing+ CREE/CITIZEN/Bridgelux chips. The housing can be black/white finished. It is widely used for residential area or commercial lighting.

Complete Product Data

Order Number	GR-DLG-2*20WE
Total Wattage	40W±5%
Mounting Type	Recessed Mounted
Dimension(mm)	L335*W180mm
Outcut(mm)	L320*W165mm
IP Grade	IP20/IP40
Luminaries Lumens	3800-4400lm
Beam angle	15/24/36°
Working temperature	-30°C ~ +55°C
Certificates standard	CE LVD EMC RoHS
Warranty	3/5Years
Package	/

Control Gear Data

LED driver brand	DNF/GX/HG/LiFud/Eagleries Brand
Input voltage	110/220-240VAC 50/60Hz
Output voltage	30-42Vdc
Output current	1000mA
Power Factor	>0.9
Surge protection	1KV
Efficiency	>87% @230V
IP Grade	IP22
THD	<15% @230V
Dimmable	No, but available to select it as Triac/0-10V/DALI if needed
Free flicker	Yes
Protection	Short circuit, open circuit, overcurrent, overvoltage protection
Certificates	CE RoHS ENEC CB
Warranty	3/5Years

Material&Housing Data

Housing Color	Matt white/ black housing color
Housing Material	Aluminum
Trim	Metal
Reflector	polycarbonate,silver
Lens	/
Clips	Metal

Photometric Data

LED chip brand	Bridgelux / Osram
Chip type	COB
Color temperature	2700-2800K/3000-3200K/4000-4500K/ 5700-6000K/ 6000-6500K
CRI	>Ra90
Life time	>50000Hrs
Lumens	120-140lm/W
SDCM	<5
Lumens maintenance	99.9%@1000hrs/ 99%@3000hrs /98%@10000hrs. (LM80)

Optional

Dimming Type	Triac dim/ 0-10V dimmable optional
Dimming driver brand	EAGLERISE KOPU
Emergency backup	3W-7W with 1-3hours duration options

Dimension

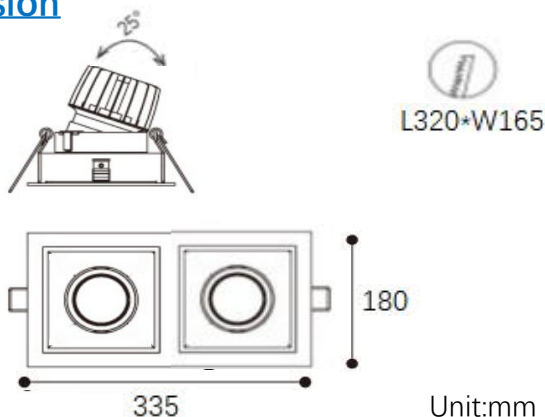

Lighting Distribution

