



RECESSED LED DOWNLIGHT

Ref No: GR-DL-24WB-01



LED Downlight delivers a superior LED alternative that's up to 60% more energy efficient than the conventional downlight retrofits. It is also ideal for all commercial lighting applications as well as public indoor space where there is limited space in the ceiling.

Complete Product Data

Order Number	GR-DL-24WB-01
Total Wattage	24W±5%
Mounting Type	Recessed mounted
Dimension(mm)	Ø220×H34mm
Outcut(mm)	Ø200-205mm
IP Grade	IP44
Luminaries Lumens	2300-2500lm
Beam angle	110° as standard
Working temperature	-25°C ~ +55°C
Certificates standard	CE LVD EMC RoHS
Warranty	3/5Years
Package	/

Control Gear/Driver Data

LED driver brand	GuanX/HG / LiFud/Eagleries/Osram/Philips brand options
Input voltage	110/220-240VAC 50/60Hz
Output voltage	30-42Vdc
Output current	600-650mA
Power Factor	0.5 as standard, >0.9 optional
Surge protection	1KV
Efficiency	>86% @230V
IP Grade	IP20
THD	<15% @230V
Dimmable	No, but available to select it as Triac/0-10V/DALI if needed
Free flicker	Yes
Protection	Open Circuit Protection / short Circuit protection/
Certificates	CE ENEC CCC CB
Warranty	3/5Years

Material&Housing Data

Housing Color	White trim finished
Housing Material	Aluminum
Heat sink	Die-cast aluminum, grey/ black finished
Reflector material	/
Fixation material	Steel
Connector	Quickly connectors

Photometric Data

LED chip brand	Bridgelux
Chip type	SMD
Color temperature	2700-2800K/3000-3200K/4000-4500K/ 5700-6000K/ 6000-6500K
CRI	>80
Life time	>50000Hrs
Lumens	120-150lm/W
SDCM	<5
Lumens maintenance	99.9%@1000hrs/ 99%@3000hrs /98%@10000hrs. (LM80)

Optional

Dimming Type	Triac dim/ 0-10V dim/ DALI dimmable optional
Dimming driver brand	KOPU EAGLERISE LIFUD
Emergency backup	Battery backup with 1-3Hours for 2-5Watt

Dimension

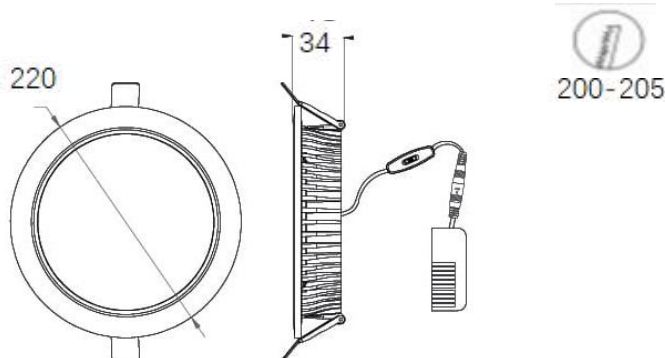

Unit:mm

Lighting Distribution

