



ADJUSTABLE DOWNLIGHT

Ref No: GR-DL-20WG-03



LED Downlight adopt deep anti-glare design, with top quality aluminum as housing and bridgelux chips, delivers a superior LED alternative that's up to 60% more energy efficient than the conventional downlight retrofits. It is also ideal for all commercial lighting applications. White/black/Silver/Gun black reflectors optional.

Complete Product Data

Order Number	GR-DL-20WG-03
Total Wattage	20W±5%
Mounting Type	Recessed mounted
Dimension(mm)	Φ105*H115mm
Outcut(mm)	Ø95mm
IP Grade	IP22
Luminaries Lumens	1900-2200lm
Beam angle	15/24/36°.
Working temperature	-25°C ~ +55°C
Certificates standard	CE LVD EMC RoHS
Warranty	3/5Years
Package	/

Control Gear/Driver Data

LED driver brand	LiFud EAGLERISE OSRAM
Input voltage	110/220-240VAC 50/60Hz
Output voltage	30-42Vdc
Output current	450-500mA
Power Factor	>0.5 or >0.9 option
Surge protection	1-2KV
Efficiency	>86% @230V
IP Grade	IP20
THD	<15% @230V
Dimmable	No, but available to select it as Triac/0-10V/DALI if needed
Free flicker	Yes
Protection	Open Circuit Protection / short Circuit protection/
Certificates	CCC、RCM、CE、CB
Warranty	3/5Years

Material&Housing Data

Housing Color	White finished
Housing Material	Aluminum
Lens	High quality PC lens
Reflector material	PC reflector, white as standard, black/silver/gun optional
Fixation material	Steel
Connector	Quickly connectors



Photometric Data

LED chip brand	Bridgelux
Chip type	COB
Color temperature	2700-2800K/3000-3200K/4000-4500K/ 5700-6000K/ 6000-6500K
CRI	>Ra90
Life time	>50000Hrs
Lumens	110-130lm/W
SDCM	<5
Lumens maintenance	99.9%@1000hrs/ 99%@3000hrs /98%@10000hrs. (LM80)

Optional

Dimming Type	Triac dim/ 0-10V dim/ DALI dimmable optional
Dimming driver brand	KOPU EAGLERISE OSRAM EUCHIPS Lifud
Emergency backup	Battery backup with 1-3Hours for 3-5Watt

Dimension

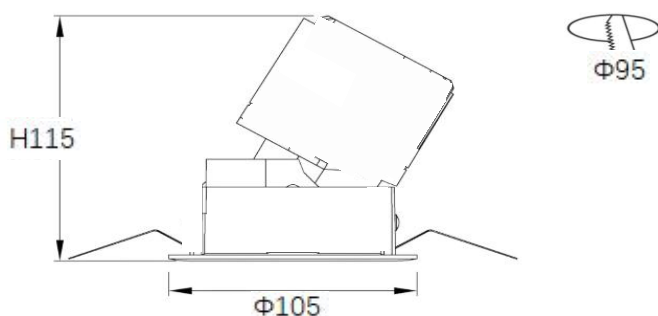

Lighting Distribution

