



GIMBAL LED DOWNLIGHT

Ref No: GR-DL-10WG-02

CE RoHS IP22



LED Downlight is gimable design, It can rotate 350° horizontally and stretch 75° vertically. Heat sink is aluminum, Light source is CRI92 COB led chips,high brightness, It is also ideal for all commercial lighting applications as well as public indoor space where there is limited space in the ceiling.

Complete Product Data

Order Number	GR-DL-10WG-02
Total Wattage	10W±5%
Mounting Type	Recessed
Dimension(mm)	∅ 90*100mm
Outcut(mm)	∅ 75-80mm
IP Grade	IP22
Luminaries Lumens	900-1100lm
Beam angle	15/24/36°
Working temperature	-30°C ~ +55°C
Certificates standard	CE LVD EMC RoHS
Warranty	3/5Years
Package	/

Control Gear Data

LED driver Type	Guanx/DNF/LiFud/Osram/Philips/Eagleries optional
Input voltage	110/220-240VAC 50/60Hz
Output voltage	30-42Vdc
Output current	250-300mA
Power Factor	>0.5 standard or >0.85 options with higher cost
Surge protection	1KV
Efficiency	>86% @230V
IP Grade	IP22
THD	<20% @230V
Dimmable	No, but available to select it as Triac/0-10V/DALI if needed
Free flicker	Yes
Protection	Short circuit, open circuit, overcurrent, overvoltage protection
Certificates	/
Warranty	3/5Years

Material&Housing Data

Housing Color	Matt white trim
Housing Material	Aluminum
Lens	PMMA
Reflector	/
Cover	/
Clips	Metal

Photometric Data

LED chip brand	Bridgelux /Osram
Chip type	COB
Color temperature	2700-2800K/3000-3200K/4000-4500K/ 5700-6000K/ 6000-6500K
CRI	>Ra90
Life time	>50000Hrs
Lumens	120-150lm/W
SDCM	<5
Lumens maintenance	99.9%@1000hrs/ 99%@3000hrs /98%@10000hrs. (LM80)

Optional

Dimming Type	Triac dim/ 0-10V dimmable optional
Dimming driver brand	EAGLERISE KOPU
Emergency backup	Battery backup for 1-3W with 1-3hrs duration

Dimension

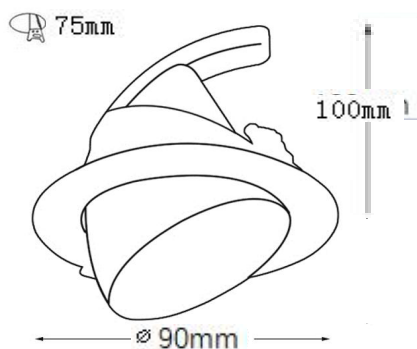

Lighting Distribution

