



LED MODULAR FLOODLIGHT

Ref No: GR-FL-50WM



This Flood light is consist of different number of modular sources,each modular is 50Watt,delivers a superior LED alternative that'sup to 60% more energy efficient than the conventional HPS,Metal halide flood light retrofits. It is widely used for different outdoor places such as tunnel,high mast,squares,stadium fields(football field,tennis court,basketball etc)

Complete Product Data

Order Number	GR-FL-50WM
Total Wattage	50W±5%
Mounting Type	Wall mounted/Pole mounted/ground mounted
Dimension(mm)	75*315*140
Outcut(mm)	/
IP Grade	IP66
Luminaries Lumens	6000-7000lm
Beam angle	120°/75*140°
Working temperature	-25°C ~ +55°C
Certificates standard	CE LVD EMC RoHS
Warranty	3/5Years
Package	/

Control Gear Data

LED driver Brand	SUNCOM / MEANWELL / OSRAM /MOSO
Input voltage	100/220-277VAC 50/60Hz
Output voltage	30-48Vdc
Output current	900-1000mA
Power Factor	>0.95
Surge protection	6-10KV
Efficiency	>91% @230V
IP Grade	IP66
THD	<10% @230V
Dimmable	No, but available to be PWM/0-10V/DALI
Free flicker	/
Protection	Short circuit, open circuit, overcurrent, overvoltage protection
Certificates	TUV, CE, CB,ENEC, UL
Warranty	3/5Years

Material&Housing Data

Housing Color	Black
Housing Material	Die-cast aluminum
Cover material	PMMA cover
Reflector	/
Bracket	Metal
Screws	Stainless steel

Photometric Data

LED chip brand	Philips/Bridgelux
Chip type	SMD 3030/2835
Color temperature	2700-2800K/3000-3200K/4000-4500K/ 5700-6000K/ 6000-6500K
CRI	>Ra70 or 80
Life time	>50000Hrs
Lumens	150-160lm/W
SDCM	<5
Lumens maintenance	99.9%@1000hrs/ 99%@3000hrs /98%@10000hrs. (LM80)

Optional

Dimming Type	PWM/0-10V/ DALI dimmable
Dimming driver brand	Osram/ Moso /SUNCOM/ Meanwell
Emergency backup	10-18W with 1-2hours duration
Input voltage	AC/DC12V/24V/48V optional
Shading cover	/

Dimension

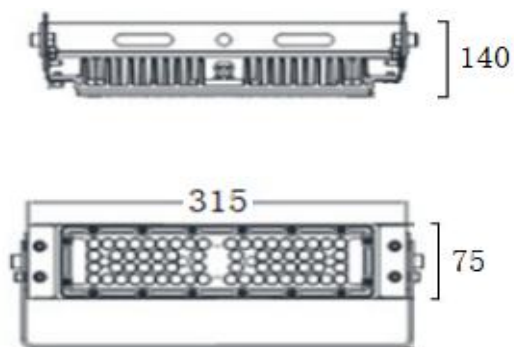

Unit:mm

Lighting Distribution

