



RECESSED DOWNLIGHT

Ref No: GR-DL-10WG-08



LED Downlight adopt gimbal design, it is ok to be [rotation 350°+ up down adjust 25°](#), and consists of CREE/CITIZEN/Bridgelux chips, delivers a superior LED alternative that's up to 60% more energy efficient than the conventional downlight retrofits. Widely used for commercial projects.

Complete Product Data

Order Number	GR-DL-10WG-08
Total Wattage	10W±5%
Mounting Type	Recessed mounted
Dimension(mm)	Φ90*H98mm
Outcut(mm)	Φ75-80mm
IP Grade	IP22
Luminaries Lumens	900-1100lm
Beam angle	15/24/36°
Working temperature	-30°C ~ +55°C
Certificates standard	CE LVD EMC RoHS
Warranty	3/5Years
Package	/

Electrical Data

LED driver brand	GuanX/Eagleries/LiFud as standard, Philips/Osram optional
Input voltage	220-240VAC 50/60Hz
Output voltage	30-42Vdc
Output current	250-300mA
Power Factor	>0.5 as standard, >0.85 optional
Surge protection	1KV
Efficiency	>87% @230V
IP Grade	IP22
THD	<15% @230V
Dimmable	No, but available to select it as Triac/0-10V/DALI if needed
Free flicker	Yes
Protection	Short circuit, open circuit, overcurrent, overvoltage protection
Certificates	CE, ENEC, RCM CB, CCC
Warranty	3/5Years

Material&Housing Data

Housing Color	White trim and black heat sink
Housing Material	Aluminum
Cover material	polycarbonate Cover
Reflector	/
Lens	PMMA
Clips	Metal

Photometric Data

LED chip brand	Bridgelux /Osram / Citizen optional
Chip type	COB
Color temperature	2700-2800K/3000-3200K/4000-4500K/ 5700-6000K/ 6000-6500K
CRI	>Ra90
Life time	>50000Hrs
Lumens	120-150lm/W
SDCM	<5 or <3
Lumens maintenance	99.9%@1000hrs/ 99%@3000hrs /98%@10000hrs. (LM80)

Optional

Dimming Type	Triac dim/ 0-10V dim/ DALI dimmable optional
Dimming driver brand	EAGLERISE KOPU
Emergency backup	Battery backup with 1- 3Hours for 2-5Watt

Dimension

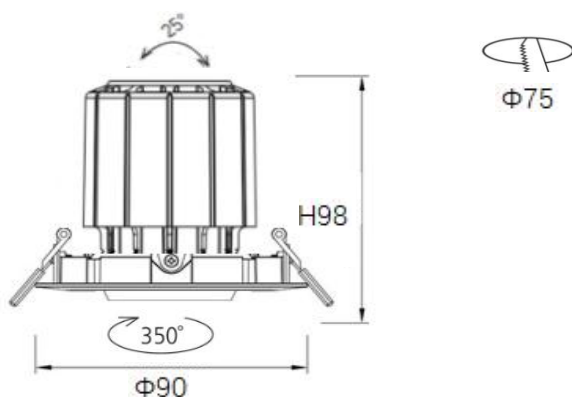

Unit:mm

Lighting Distribution

