

GR-HB-150WB-02 Sensor High Bay

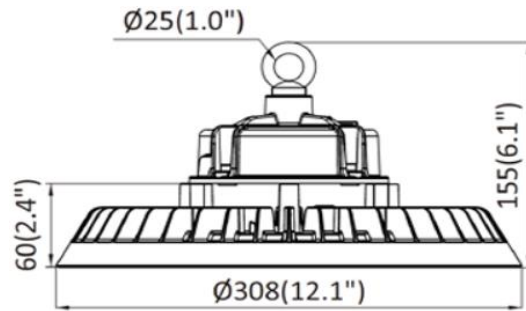

Dimension



Unit:mm

Description&Feature

This is a high-quality microwave radar motion sensor high bay led light. It uses wireless transmission and [microwave sensors](#). When it senses the movement of the human body or other objects, it can automatically turn on the brightness to 100%. If there is no moving object, the lamp will keep at 20%. -30% brightness, can save energy to the greatest extent. Its lifetime can be up to 10years. The other extra function such as 0-10V dimming can be available. It is widely used for warehouse, factories, workshops etc.

Light Distribution Curve

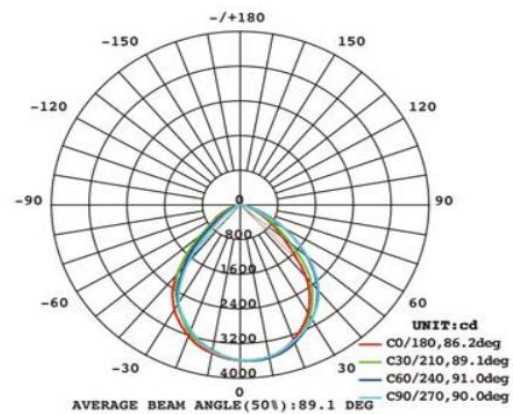

Specification

Model	GR-HB-150WB-02
Dimension(mm)	Ø308*155mm
Outcut	/
Power	150W±5%
LED Chips brand	Philips/Bridgelux SMD3030/2835
Lumens	22000-23000lm
Color temperature	3000K/4000K-4500K/6000K-6500K
Driver	Isolated driver/Meanwell/Philips/DONE Brand driver options
Input voltage	85-265VAC 50/60Hz
Power factor	>0.95
CRI	>80
Sensor distance	12-16meter
Working life	>50000Hrs
Efficiency	>90%
Materials	Die-cast aluminum+PC
Beam angle	90°
THD	<10%
IP Grade	IP65 waterproof
Dimmable	No. but it is ok to do 0-10V Dimming if needed
Working temperature	-25°C~+55°C
Storage temperature	-30°C~+60°C
Standard	CE LVD EMC RoHs
Warranty	3/5Years options