

# GR-DL-20WW Waterproof downlight

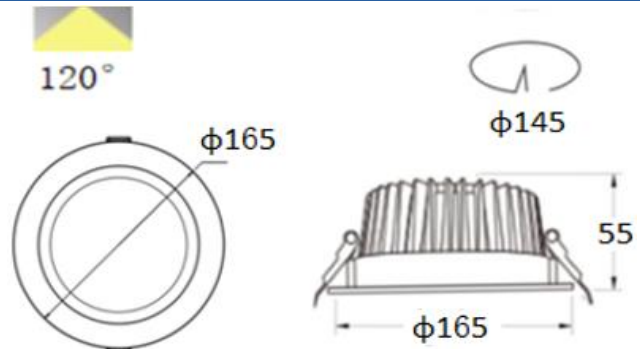

## Dimension



Unit:mm

## Description&Feature

This downlight is improved from common downlight adding a waterproof rubber, to increase protection level up to be IP65, so that it can be used for some moisture environments such as kitchen, balcony, or bathroom. It is made of die-cast aluminum and High CRI, Lumens COB chips. It is perfect solution to do projects

Its lifetime can be up to 50000Hrs at least  
The other extra function such as 0-10V, DALI dimmable/Smart APP Control/Remote control/3CT also can be available.

## Light Distribution Curve

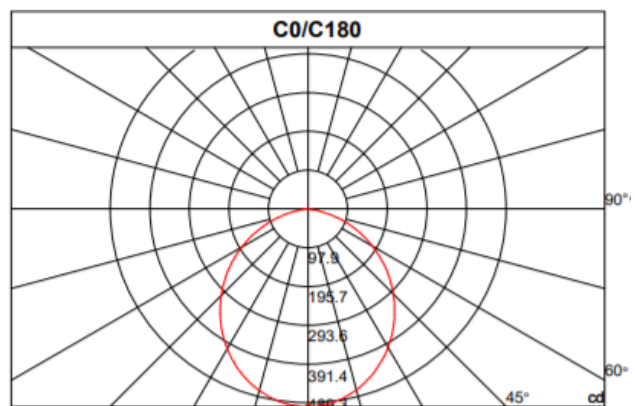

## Specification

Order Model	GR-DL-20WW
Dimension(mm)	φ165XH55mm
Outcut(mm)	φ145mm
Wattage	20W±5%
LED Chips brand	CREE/CITIZEN/Bridgelux COB
Lumens	1800-2000lm
Color temperature	3000K/4000K-4500K/6000K-6500K
Input voltage	100-240VAC 50/60Hz/220-240VAC
Driver	Included top quality isolated driver(DONE/Philips options)
Power factor	>0.5 or >0.9 if needed
CRI	>90
SDCM	<5 ( <3 available)
Working life	>50000Hrs
Efficiency	>86%
Materials	Aluminum body+glass cover+waterproof rubber, White frame finished
Beam angle	120°
Installation	Recessed
IP Grade	IP65 Waterproof
Dimmable	No. but it is ok to do 0-10V/DALI Dimming if needed
Working temperature	-25°C~+50°C
Storage temperature	-30°C~+55°C
Standard	CE LVD EMC RoHs
Warranty	3/5Years