

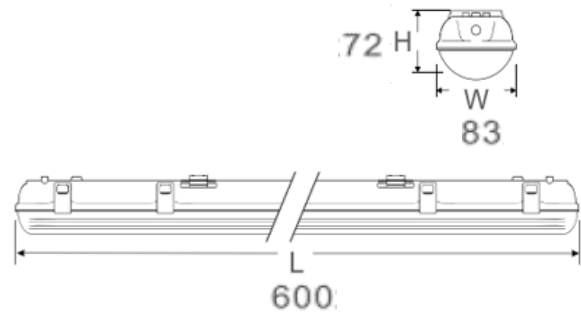

Dimension



Unit:mm

Description&Feature

LED Triproof batten is a superior LED alternative that's up to 60% more energy efficient than the conventional light retrofits. It is with SMD LED Chips, highest brightness, and body with stainless steel clips. protection level up to IP65, it is working well in bad environments.

The good materials like constant current driver, high brightness led chips, will make sure it will be a long lifespan. It is widely used for warehouse, parking lots, residential or commercial, industrial areas.

Light Distribution Curve

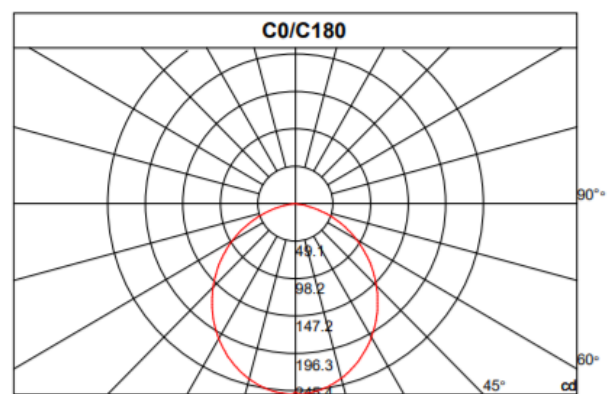

Specification

Order Model	GR-TPD-2F18WB
Dimension(mm)	600*83*72mm
Base	/
Power	20W±5%
LED Chips brand	Epistar SMD Led chips 120PCS
Lumens	1900-2100lm
Color temperature	3000K/4000K-4500K/6000K-6500K
Driver	Included stable constant current led driver
Input voltage	200-240VAC 50/60Hz
Power factor	>0.9
CRI	>80
SDCM	<5
Working life	>50000Hrs
Efficiency	>88%
Materials	PC body+frosted cover+Stainless clips
Beam angle	120°
IP Grade	IP65 Waterproof
Emergency kits	Emergency 9-12W duration 2-3hrs available
Dimmable	No.
Working temperature	-30°C~+55°C
Storage temperature	-35°C~+60°C
Installation	Surface mounted
Warranty	2/3/5Yrs