

GR-DL-35WR LED Downlight

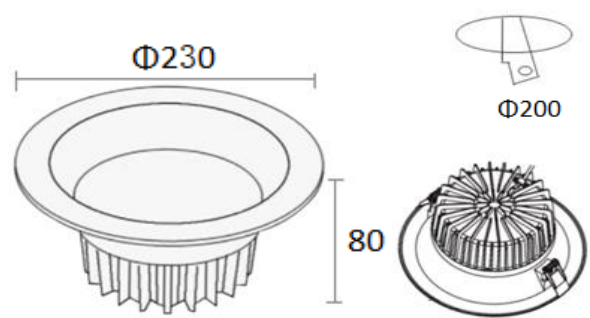

Dimension



Unit:mm

Description&Feature

LED Downlight adopt deep anti-glare design with UGR<19, with top quality aluminum as housing and CREE/CITIZEN/Bridgelux chips,delivers a superior LED alternative that'sup to 60% more energy efficient than the conventional downlight retrofits. It is also ideal for all commercial lighting applications

Its lifetime can be up to 10years.
It is the perfect solution for commercial lighting.
The other extra function such as dimming/
emergency backup/Zigbee smart control also can be available.

Light Distribution Curve



Specification

Order Model	GR-DL-35WR
Dimension(mm)	ø230×H80mm
Outcut	Φ200mm
Power	35W±5%
LED Chips brand	CREE/CITIZEN/Bridgelux COB chips
Lumens	3200-3500lm
Color temperature	3000K/4000K-4500K/6000K-6500K
Driver	Philips/Osram/DONE/Eagerise/Boke/LiFud etc Top brand
Input voltage	100-240VAC / 220-240VAC 50/60Hz
Power factor	>0.6 or >0.9 if needed
CRI	>90
SDCM	<5 (<3 available)
Working life	>50000Hrs
Efficiency	>89%
Materials	Die-cast aluminum,White finished
Beam angle	90/100°
IP Grade	IP22 indoor use only
Emergency kits	No. but it is ok to do emergency backup for 30% power with 1hrs 2hrs 3hrs duration
Dimmable	No. but it is ok to do Triac/0-10V/DALI/Zigbee smart control if needed
Working temperature	-25°C~+55°C
Storage temperature	-30°C~+60°C
Standard	CE LVD EMC RoHs
Warranty	3/5Years