

GR-UL-9WA Underwater Light

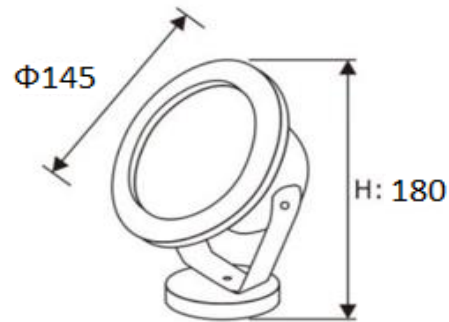

Dimension



Unit:mm

Description&Feature

This is Led underwater light, it is ok to be placed into water for pools, fountains or swimming rooms etc. It is made of stainless steel body,toughed glass cover, waterproof rubber,protection level up to IP68. Rotate 360° horizontally, and adjust the irradiation angle vertically. The color temperature can be single warm white, white, Green,Red,Blue or RGB.

The input voltage only is low voltage like AC/DC12V 24V. What is more, dimmable,DMX512 control also can be available if needed.

Application



Specification

Order Model	GR-UL-9WA
Diameter(mm)	Φ145*H180mm
Outcut	/
Power	9W±5%
LED Chips brand	Bridgelux Chips 9PCS
Lumens	810-900lm
Color temperature	3000K/4000K-4500K/6000K-6500K/Red/Blue/Green/RGB
Installation	Mounting base
Input voltage	DC24V as standard, other AC/DC12V available
Power factor	>0.9
CRI	>80
SDCM	<5
Working life	>50000Hrs
Efficiency	>88%
Materials	Stainless steel body+Toughed glass cover
Beam angle	30°
IK Rating	IK07
IP Grade	IP68 waterproof
Dimmable	No.(It is ok to do triac/0-10v/dali if needed)
Working temperature	-25°C~+60°C
Storage temperature	-30°C~+65°C
Standard	CE LVD EMC RoHs
Warranty	2/3/5Years options