

GR-GL-36WA Inground Light

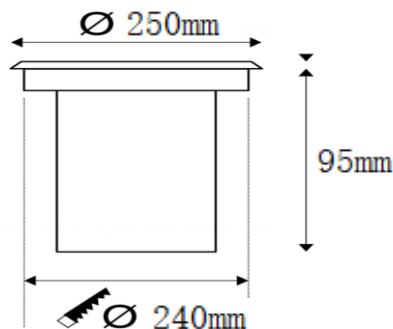

Dimension



Description & Feature

This is recessed led inground light, made of stainless steel frame, aluminum body, ABS embadded parts, and toughed glass. Waterproof level up to IP67 Max. Top quality led driver and led chips. Light colors are white, warm white, Red, Blue, Green optional. Lifetime up to 50000Hrs. Good choice to do landscape lighting.

The input voltage 100-240VAC 50/60Hz as standard, but AC/DC12V 24V can be customized as well. What is more, dimmable, DMX512 control also can be available if needed.

Light Distribution Curve

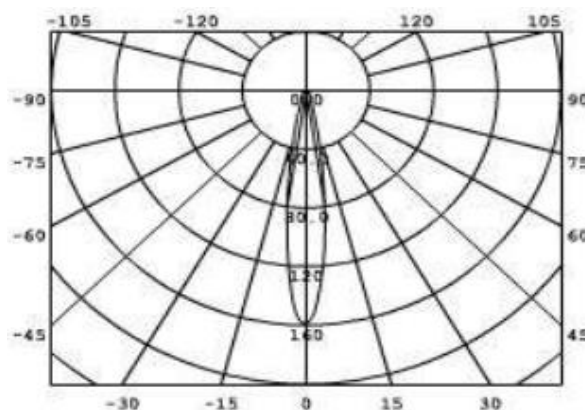

Specification

Order Model	GR-GL-36WA
Dimension(mm)	Φ250*H95mm
Outcut	Φ240-245mm
Power	36W±5%
LED Chips brand	Epistar/Bridgelux Chips
Lumens	3250-3600lm
Color temperature	3000K/4000K-4500K/6000K-6500K/Red/Blue/Green
Driver	Isolated driver included
Input voltage	100-240VAC / 220-240VAC 50/60Hz
Power factor	>0.5
CRI	>80
SDCM	<5
Working life	>50000Hrs
Efficiency	>88%
Materials	Stainless steel frame+ Die-cast aluminum body+Toughed glass cover
Beam angle	30°
IK Rating	IK08
IP Grade	IP67 waterproof
Dimmable	No.(It is ok to do triac/0-10v/dali if needed)
Working temperature	-25°C~+60°C
Storage temperature	-30°C~+65°C
Standard	CE LVD EMC RoHs
Warranty	2/3/5Years options