

GR-FM-70WB Surface Downlight

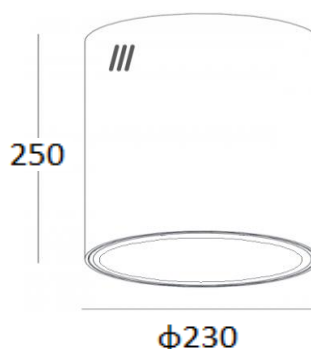

Dimension



Unit:mm

Description&Feature

LED Downlight is surface solution, made of metal, aluminum and reflectors. Black/White housing finished available. And it is available to do suspension installation with extra ropes. High CRI, High Lumens output, stable quality, making it to be a perfect choices for commercial lighting.

Its lifetime can be up to 10years.
It is the perfect solution for commercial lighting.
The other extra function such as dimming/ Zigbee smart control also can be available.

Light Distribution Curve

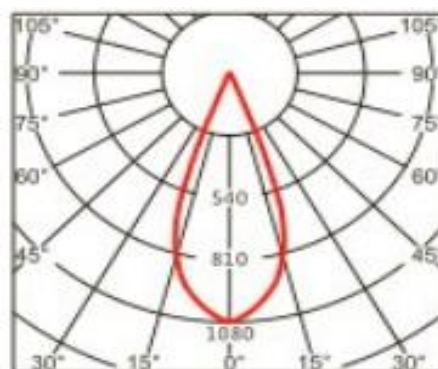

Specification

Order Model	GR-FM-70WB
Dimension(mm)	φ230*H250mm
Outcut	/
Power	70W±5%
LED Chips brand	Osram/CREE/CITIZEN/Bridgelux COB Led chips
Lumens	6300-7000lm
Color temperature	3000K/4000K-4500K/6000K-6500K
Driver	Philips/Osram/DONE/Eagerise/Boke/LiFud etc Top brand
Input voltage	100-240VAC / 220-240VAC 50/60Hz
Power factor	>0.6 or >0.9 if needed
CRI	>92
SDCM	<5 (<3 available)
Working life	>50000Hrs
Efficiency	>87%
Materials	Metal body+aluminum heat sink+Reflector,Black/White finished
Beam angle	30/60°
IP Grade	IP22 indoor use only
Installation	Surface as standard, but it is ok to do suspension installation with ropes as well
Dimmable	No. but it is ok to do Triac/0-10V/DALI Dimming if needed
Working temperature	-30°C~+55°C
Storage temperature	-35°C~+60°C
Standard	CE LVD EMC RoHs
Warranty	2/3/5Years

