

GR-SL-150WT LED Street Lights

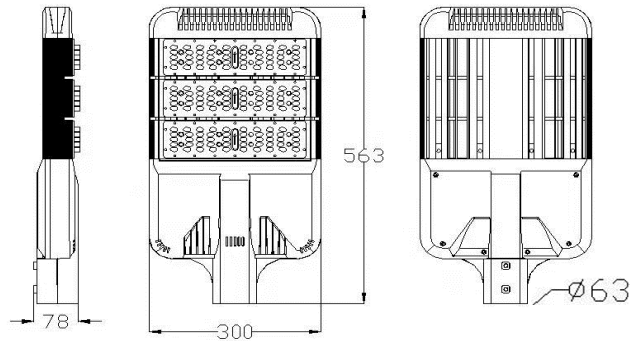

Dimension



Unit:mm

Description&Feature

LED Street light,delivers a superior LED alternative that's up to 60% more energy efficient than the conventional HPS,Metal halide road light retrofits. Top materials such as aluminum housing,isolated driver with 6kv surge protection which will keep its stable quality.The high lumens output will provide the highest brightness.

Its lifetime can be up to 10years. The other extra function such as dimming/ photocell also can be available.

Light Distribution Curve

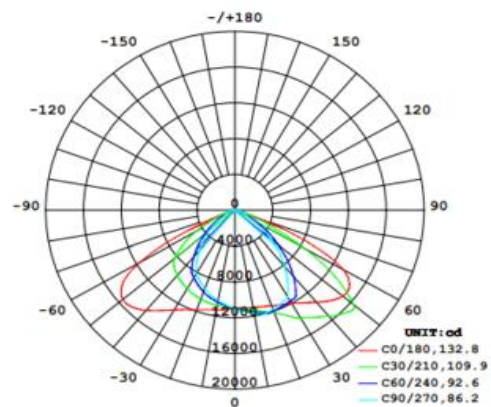

Specification

Model	GR-SL-150WT
Dimension(mm)	L563*W300*H78mm
Install hole(mm)	φ60mm
Power	150W±5%
LED Chips brand	Philips/Osram/Bridgelux SMD3030
Lumens	16500-22500lm
Color temperature	3000K/4000K-4500K/6000K-6500K
Driver	Isolated driver included(Meanwell/DONE/Philips options)
Input voltage	100-240VAC / 220-240VAC 50/60Hz
Power factor	>0.95
CRI	>80
THD	<10%
Working life	>50000Hrs
Efficiency	>90%
Materials	Die-cast aluminum+PC
Beam angle	70*140°
Surge protection	6KV(10KV/20KV options)
IP Grade	IP65 waterproof
Dimmable	No. but it is ok to do Triac/0-10V/DALI Dimming if needed
Working temperature	-30°C~+55°C
Package	430*580*105Mm/pcs/CTN
Standard	CE LVD EMC RoHs
Warranty	2/3/5Years options