

GR-FL-500WK Led Flood Lights

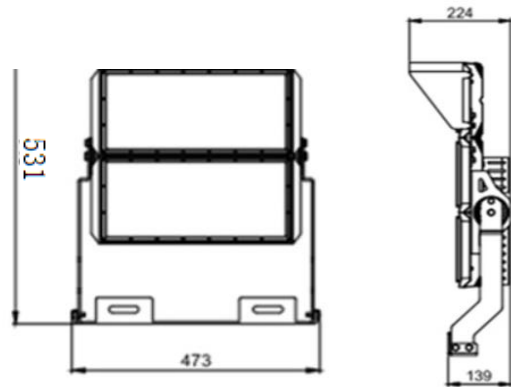

Dimension



Unit:mm

Description&Feature

This Flood light is consist of different number of modular sources,each modular is 250Watt,delivers a superior LED alternative that'sup to 60% more energy efficient than the conventional HPS,Metal halide flood light retrofits.

There are 15°/30°/45°/60°/90° beam angle optional,it is widely used for different outdoor places such as tunnel,high mast,squares,stadium fields(football field,tennis court,basketball etc)

Its lifetime can be up to 10years. The other extra function such as dimming/ photocell also can be available.

Light Distribution Curve

15°/30°/45° /60°/90° options

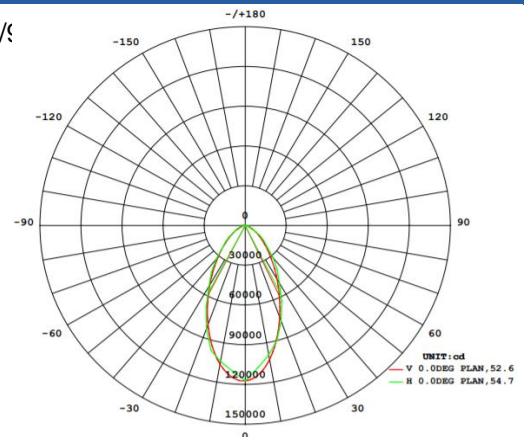

Specification

Model	GR-FL-500WK
Dimension(mm)	473*531*224mm
Surge protection	6KV(10KV 20KV available)
Power	500W±5%
LED Chips brand	Philips/Osram/Bridgelux SMD3030
Lumens	60000-75000lm
Color temperature	3000K/4000K-4500K/6000K-6500K
Driver	Isolated driver included(Meanwell/DONE/Philips options)
Input voltage	100-240VAC / 220-240VAC 50/60Hz
Power factor	>0.95
CRI	>80
SDCM	<5
Working life	>50000Hrs
Efficiency	>90%
Materials	Die-cast aluminum+PC, Black Finished
Beam angle	15°/30°/45°/60°/90° optional
THD	<10%
IP Grade	IP65 waterproof
Options	Photocell/Time control/ Triac/0-10V/DALI Dimming if needed
Working temperature	-30°C~+55°C
Dimmable	No
Standard	CE LVD EMC RoHs
Warranty	3/5Years options