

There are 3 different tracks installations.They are a little difference in installation.

## Surface installation

Magnetic installation for every light fixtures without any tool

Just use screws to fix track onto ceiling or wall.

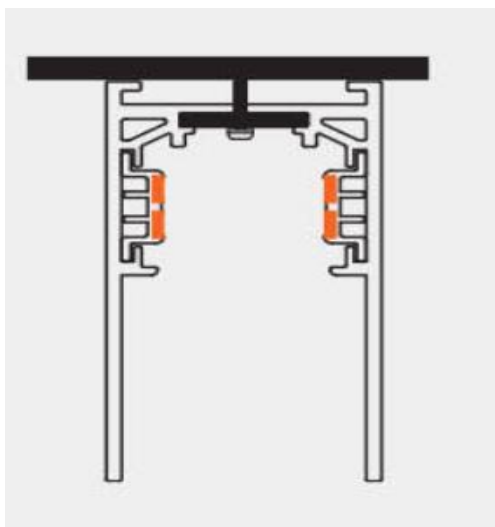
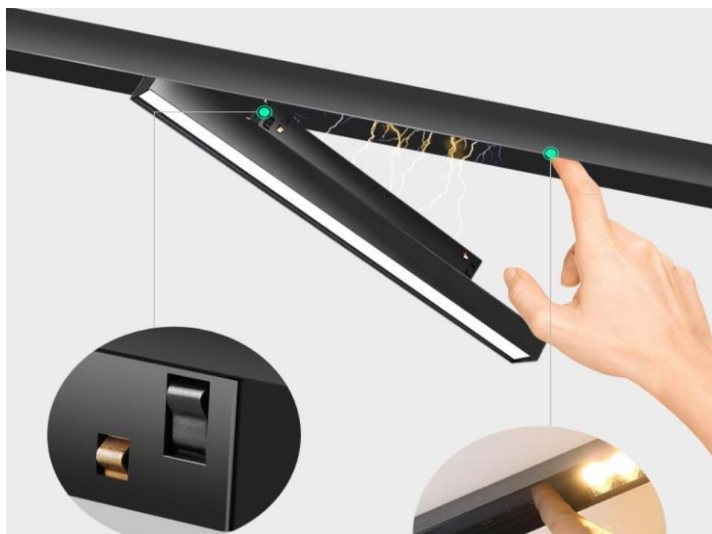

## Pendant installation



## Recessed track installation

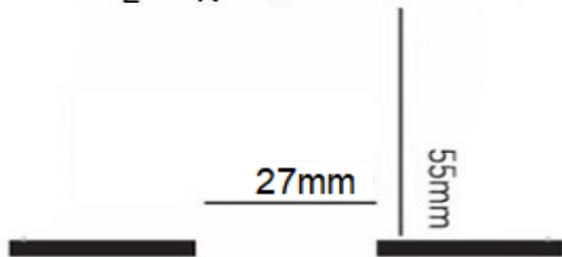
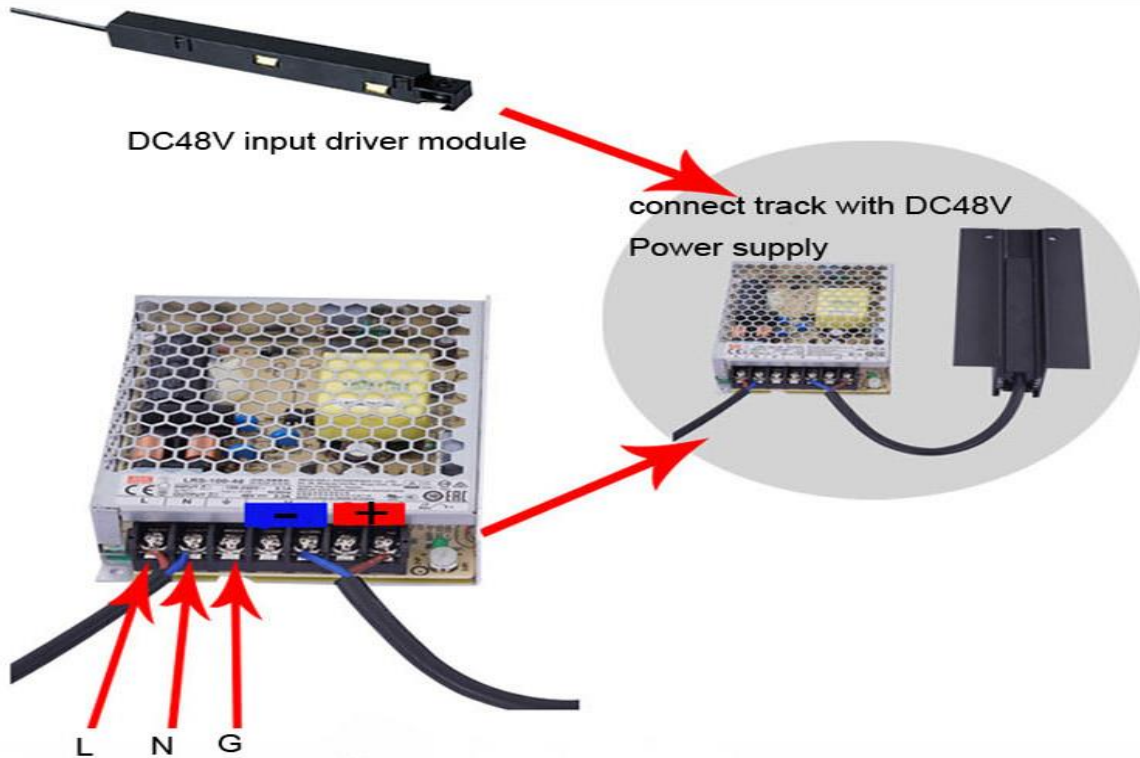

1. Opening **27mm** in ceiling

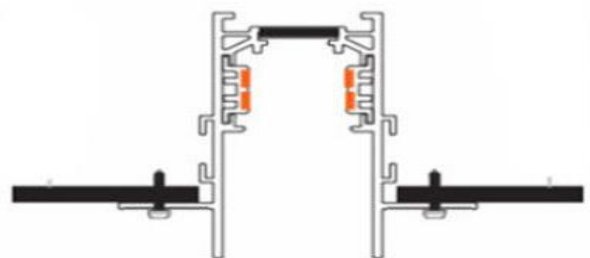

2. Put the track into the hole slot and fix the track with screws

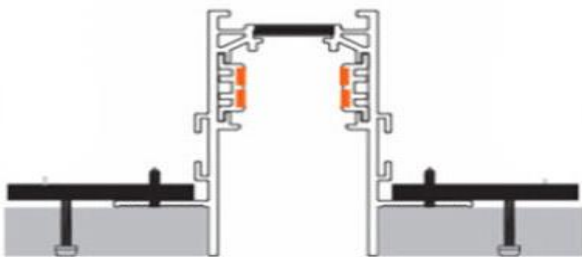

3. Cover the track with gypsum board to block the wing edge of the track and fix it with screws

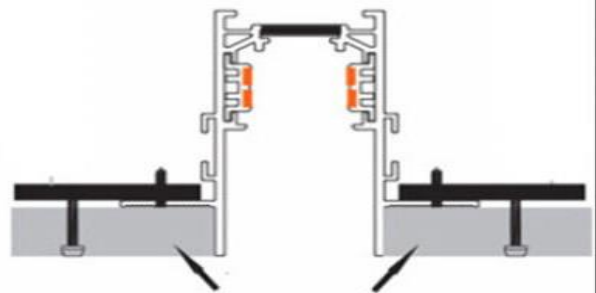

4. Then plaster the plaster board